

Sistema de Corredera S21

Línea de alto rendimiento constructivo que permite con su configuración de perfiles lograr una diversidad de modelos y aplicaciones. Permitiendo cristal simple y DVH con el cual aumentan las prestaciones térmicas y acústicas.

1

FIJA

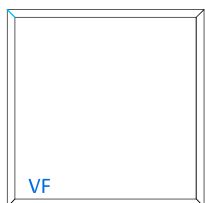
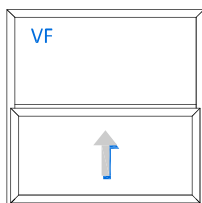

GUILLOTINA

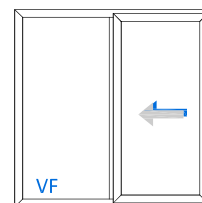
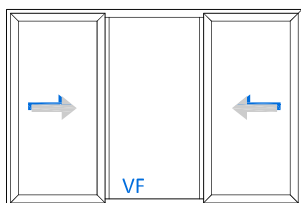
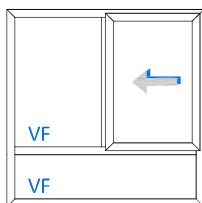
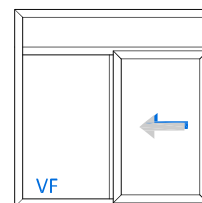
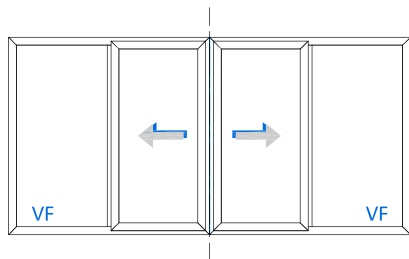
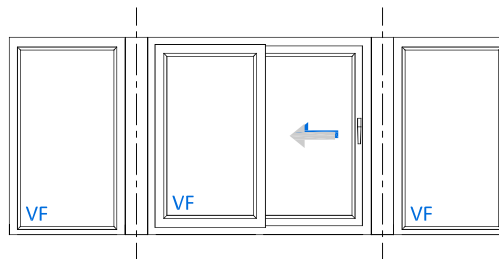
 CORREDERA 1 HOJA
1 FIJO

 CORREDERA 2 HOJA
FIJO CENTRAL

 CORREDERA 1 HOJA
FIJO INFERIOR Y LATERAL

 CORREDERA 1 HOJA
FIJO SUPERIOR Y LATERAL

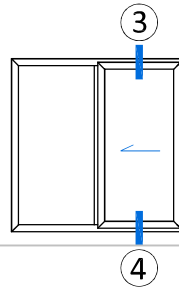
 CORREDERA 2 HOJAS
2 FIJOS LATERALES

BOW WINDOWS

Combinación de Perfiles

Marco	SSC35
Hoja	SSS29
Junquillo	BV50T



Detalle 3

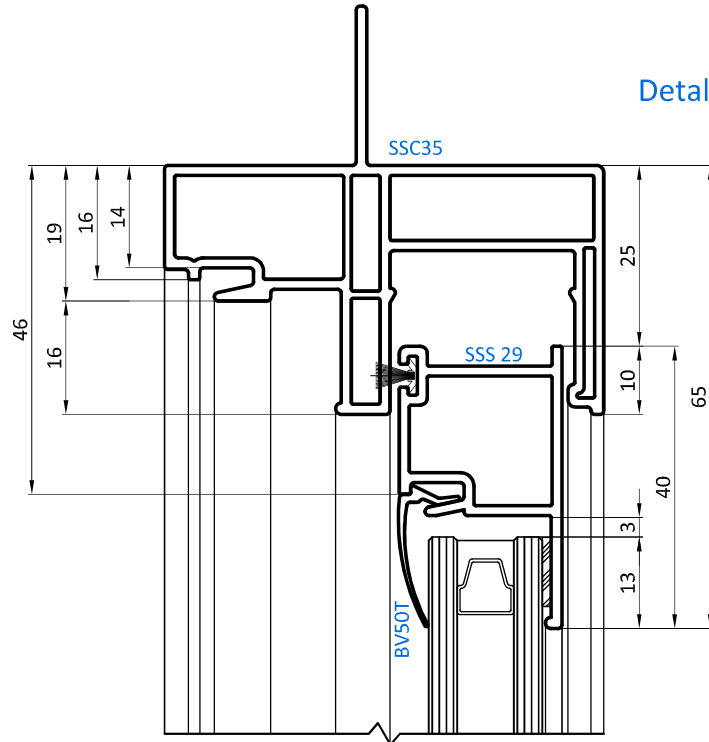

E
x
t
e
r
i
o
r

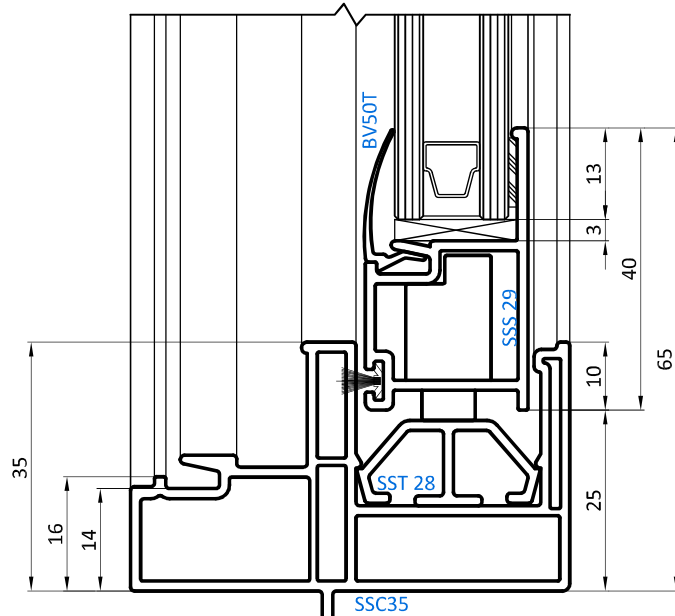

Detalle 4

4

Combinación de Perfiles

Marco	SSC35
Hoja	SSS29
Traslapo Fijo Reforzado	SHS240
Traslapo Movil	SHS26
Junquillo	BV50T

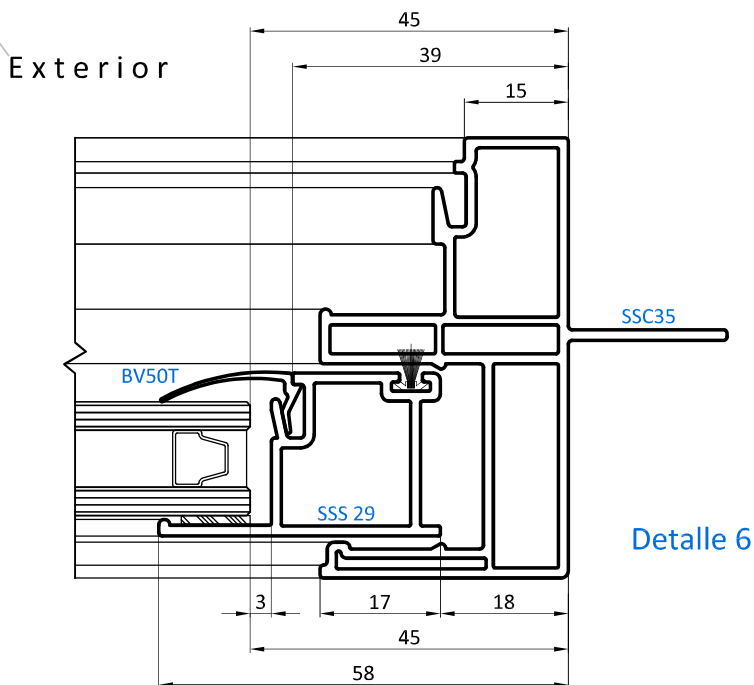
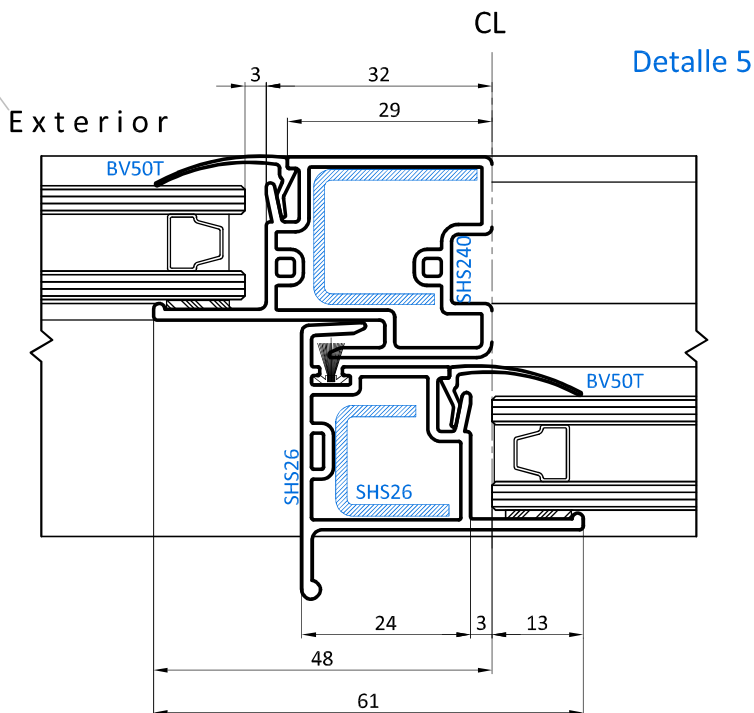
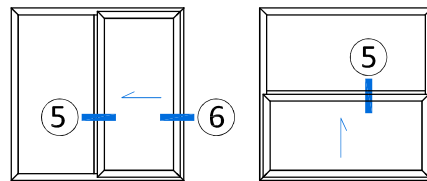

4

Combinación de Perfiles

Travesaño	SSL220
Hoja	SSS29
Junquillo	BV50T

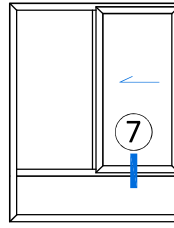

Detalle 7

4

